

Touchstone Woodworks

Three season porch featuring Touchstone Woodworks' custom mahogany Wellington style wall panels and double doors with interchangeable screens and tempered glass storms.



Touchstone Woodworks

Three season porch featuring Touchstone Woodworks' custom mahogany Wellington style wall panels and Bristol style double doors with interchangeable screens and tempered glass storms. Finished with Sikkens Natural Oak.



Touchstone Woodworks

Wellington Style Custom Mahogany Screen-Storm Door



This door is finished with 3 coats of Dark Oak Sikkens



Two removable panels sit in a rabbet, flush with the inside of the door, dividing at the middle rail. They are easily removed with a flat head screwdriver. The aluminum screen and storm frames are available in dark bronze or white.

Our doors are a full 1-1/4" thick mahogany with mortise and tenon joinery, epoxied and pegged through with mahogany pegs. All our doors are designed to accept removable and interchangeable screens and tempered glass storms like the Wellington style shown here. The removable screen and storm panels are secured with machine screws and shoulder washers that screw into metal threaded inserts, imbedded in the wood behind the panels. We design and proportion every door individually, to complement the features of the entry door. We offer several finish options including: oil-based primer, Penofin penetrating oil, Sikkens 3 coat premium finish or unfinished.



Touchstone Woodworks

Wellington Style Custom Mahogany Screen-Storm Door

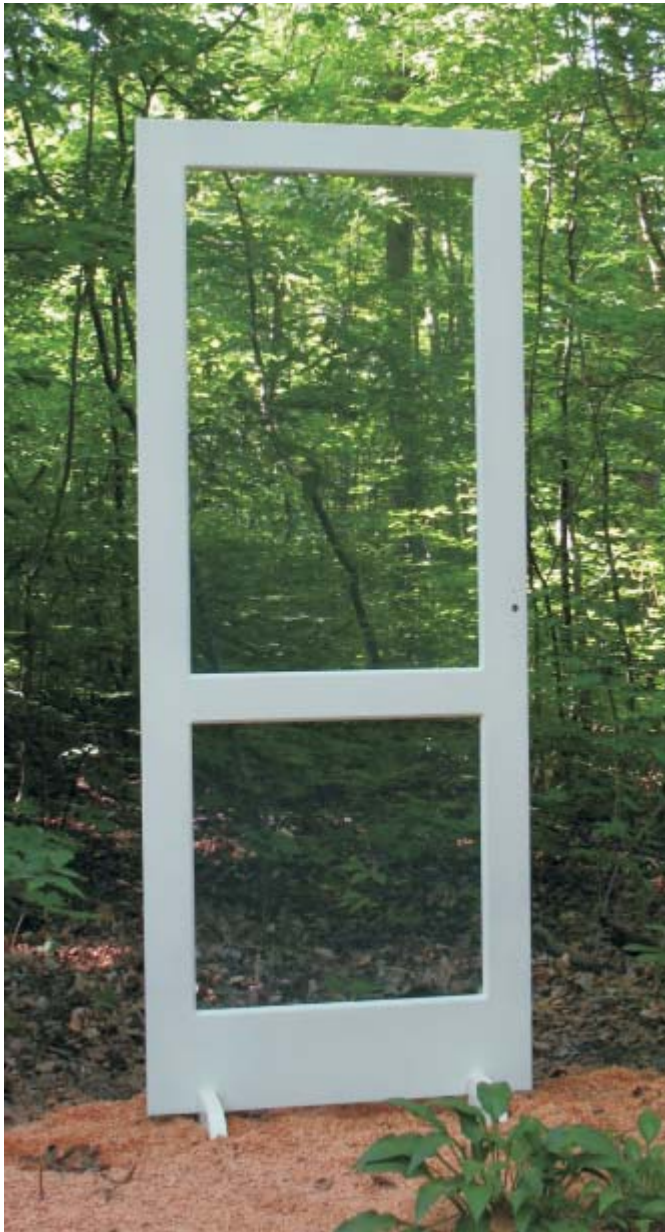

This door has an oil-based primer finish



Two removable panels sit in a rabbet, flush with the inside of the door, dividing at the middle rail. They are easily removed with a flat head screwdriver. The aluminum screen and storm frames are available in white or dark bronze.



Our doors are a full 1-1/4" thick mahogany, haunched mortise and tenon joinery, epoxied and pegged through with mahogany pegs. Our middle rails are also mortised and tenoned for added structural integrity which results in 2 removable screens and storms for styles with middle rails like the Wellington shown here.

Our base price includes: proportioning the stiles and rails of each door to complement the features of the entry door, packaging and crating, and your choice of an oil-based primer or penetrating oil finish. The screen and storm panels are secured with machine screws and shoulder washers that screw into metal threaded inserts, imbedded in the wood behind the panels.

Touchstone Woodworks

Three season porch featuring Touchstone Woodworks' custom mahogany Hatteras style wall panels and double doors with integrated transoms with interchangeable screens and tempered glass storms.



Touchstone Woodworks Hatteras Style Custom Mahogany Screen-Storm Door



This door is primed ready for paint.



Two removable panels sit in a rabbet, flush with the inside of the door, dividing at the middle rail. They are easily removed with a flat head screwdriver. The aluminum screen and storm frames are available in dark bronze or white.

Our doors are a full 1-1/4" thick mahogany, haunched mortise and tenon joinery, epoxied and pegged through with mahogany pegs. Our middle rails are also mortised and tenoned for added structural integrity which results in 2 removable screens and storms for styles with middle rails like the Hatteras shown here.

Our base price includes: proportioning the stiles and rails of each door to complement the features of the entry door, packaging and crating, and your choice of an oil-based primer or penetrating oil finish. The screen and storm panels are secured with machine screws and shoulder washers that screw into metal threaded inserts, imbedded in the wood behind the panels.

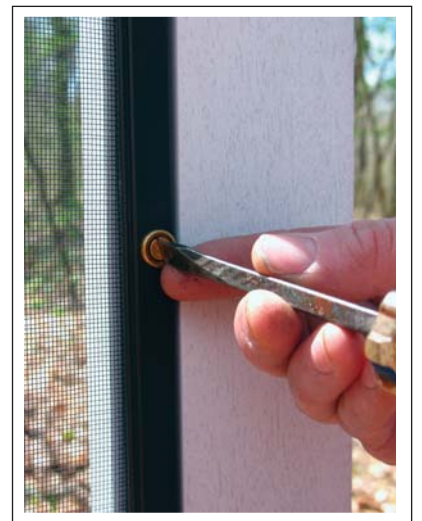

Touchstone Woodworks

Three season porch construction featuring Touchstone Woodworks' custom mahogany Brighton style doors and wall panels and divided lite transoms with interchangeable screens and tempered glass storms.



Touchstone Woodworks Brighton Style



Front (facing outside)

Our Brighton style has one horizontal raised panel and we will design and proportion it to complement your entry door. Like all of our doors, it is designed to accept a removable and interchangeable screen and tempered glass storm. The screen and storm panels are secured with machine screws and shoulder washers that screw into metal threaded inserts, imbedded in the wood behind the panels. The raised panel is a full 1-1/4" thick and raised on both sides.



The removable screen or storm panel sits in a rabbet, flush with the inside of the door. They are easily removed with a flat head screwdriver. The aluminum screen and storm frames are available in dark bronze or white.



Touchstone Woodworks Three Season Divided Lite Transom



This divided lite transom is primed and ready for paint.



The removable panel sits in a rabbet, flush with the inside of the knee wall panel. They are easily removed with a flat head screwdriver. The aluminum screen and storm frames are available in white or dark bronze.

Our divided lite transoms are a full 1-1/4" thick mahogany, mortise and tenon joinery, epoxied and pegged through with mahogany pegs.

The screen and storm panels are secured with machine screws and shoulder washers that screw into metal threaded inserts, imbedded in the wood behind the panels. Transoms can provide a source of ventilation for heat in the colder months if the room receives direct sun.





Three season porch with Touchstone Woodworks' Craftsman style mahogany door and wall panels with Sikkens Dark Oak finish.

Touchstone Woodworks

Craftsman Style Custom Mahogany Screen-Storm Doors

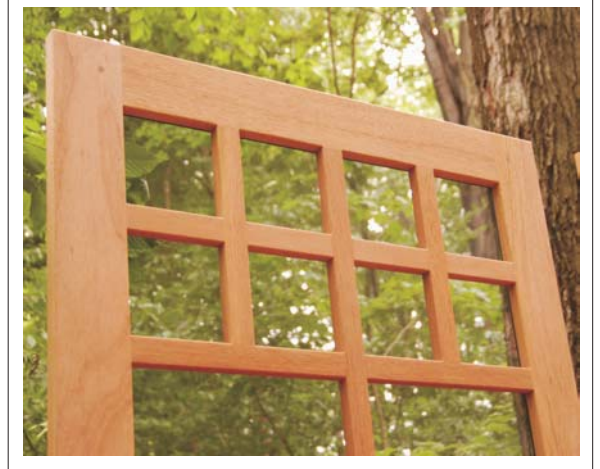

The intersecting pieces of the grillwork in our Arts & Crafts collection are 7/8" thick and are half-lapped and dowelled into the stiles and rails and receive an 1/8" roundover on the front edges. The removable screens and storms sit in a rabbet behind the grillwork, flush with the inside of the door.



Back (facing inside)

Our doors are a full 1-1/4" thick mahogany, haunched mortise and tenon joinery, epoxied and pegged through with mahogany pegs. Our middle rails are also mortised and tenoned for added structural integrity which results in 2 removable screens and storms for styles with middle rails like the Craftsman shown here. All of our doors are designed to accept removable and interchangeable screens and tempered glass storms. Or, they can be supplied with storm only or screen only, if that is your preference. Removable screen/storm panels greatly simplify long-term maintenance of the door in terms of applying and maintaining the finish, cleaning the door and glass and repairing the screen. The screen and storm panels are secured with machine screws and shoulder washers that screw into metal threaded inserts, imbedded in the wood behind the panels.



Three Season Porch
Touchstone Woodworks' Prairie View Wall Panels and single lite transoms

Touchstone Woodworks Prairie View Style Custom Mahogany Screen-Storm Door



This Prairie View style is unfinished

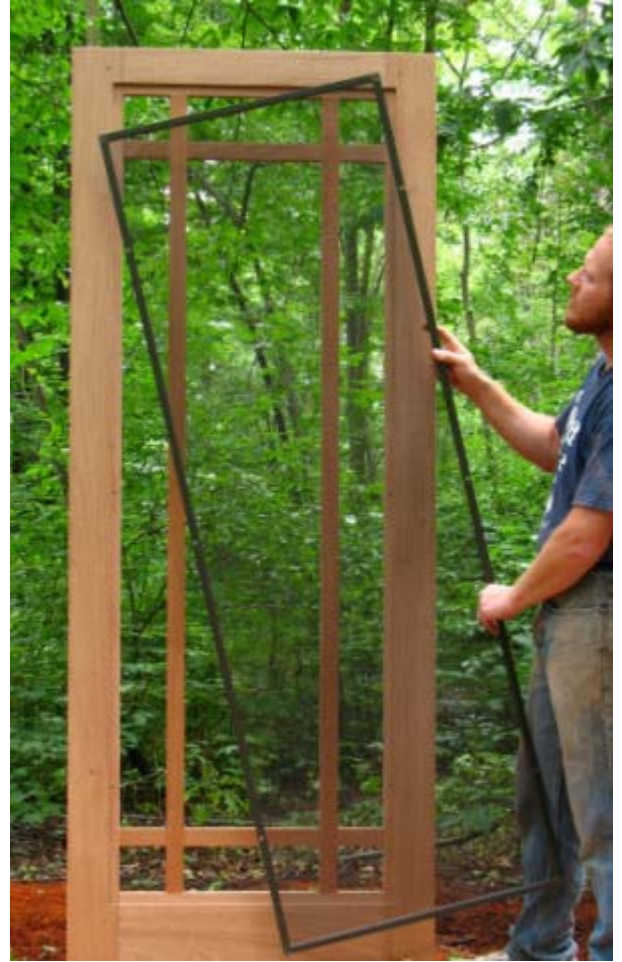

Back (facing inside)

The intersecting pieces of the grillwork in our Arts & Crafts collection are 7/8" thick and are half-lapped and dowelled into the stiles and rails and receive an 1/8" roundover on the front edges. The removable screens and storms sit in a rabbet behind the grillwork, flush with the inside of the door.

Our doors are a full 1-1/4" thick mahogany, haunched mortise and tenon joinery, epoxied and pegged through with mahogany pegs. All of our doors are designed to accept removable and interchangeable screens and tempered glass storms. Or, they can be supplied with storm only or screen only, if that is your preference. Removable screen/storm panels greatly simplify long-term maintenance of the door in terms of applying and maintaining the finish, cleaning the door and glass and repairing the screens. The screen and storm panels are secured with machine screws and shoulder washers that screw into metal threaded inserts, imbedded in the wood behind the panels. Fullview styles like this Prairie View have one removable screen and glass. Styles with a middle rail have two.



Touchstone Woodworks

Three season porch featuring Touchstone Woodworks' custom mahogany Bungalow style wall panels with interchangeable screens and tempered glass storms.





Touchstone Woodworks

Three season porch
Construction featuring
Touchstone Woodworks'
custom mahogany single lite
knee wall panels with
interchangeable screens and
tempered glass storms.



Touchstone Woodworks

Three season porch featuring Touchstone Woodworks' custom mahogany single lite knee wall panels and Wellington style door with interchangeable screens and tempered glass storms.





Touchstone Woodworks

Three season porch featuring Touchstone Woodworks' custom mahogany single lite knee wall panels, divided lite transoms and Brighton door with interchangeable screens and tempered glass storms.



Touchstone Woodworks Three Season Single Lite Knee Wall Panel



The removable panel sits in a rabbet, flush with the inside of the knee wall panel. They are easily removed with a flat head screwdriver. The aluminum screen and storm frames are available in white or dark bronze.



Our knee wall panels are a full 1-1/4" thick mahogany, mortise and tenon joinery, epoxied and pegged through with mahogany pegs.

The screen and storm panels are secured with machine screws and shoulder washers that screw into metal threaded inserts, imbedded in the wood behind the panels.

Touchstone Woodworks

Three season porch featuring Touchstone Woodworks' custom mahogany knee wall panels and Wellington style door with integrated transoms and interchangeable screens and tempered glass storms.



Touchstone Woodworks

Three Season Porch
Knee Wall Panel
with
Integrated Transom



Three season wall panels have removable and interchangeable screens and tempered glass inserts, so the room can be converted from screen to glass. Since these panels will be installed on a short wall around the room, they are called “knee wall panels”. The transom area allows for ventilation.





Three Season Porch in Madison CT featuring Touchstone Woodworks' custom mahogany divided lite knee wall panels, Wellington style door with divided lite transom. All with interchangeable screens and tempered glass storms. The wall panels, door and transom received Penofin penetrating oil finish.

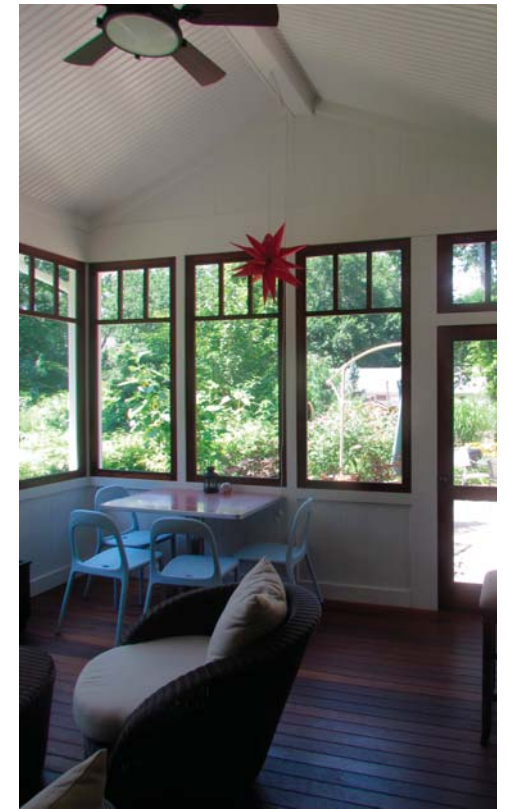

Touchstone Woodworks



Three Season Porch in Madison CT featuring Touchstone Woodworks' custom mahogany divided lite knee wall panels, Wellington style door with divided lite transom. All with interchangeable screens and tempered glass storms. The wall panels, door and transom received Penofin penetrating oil finish.

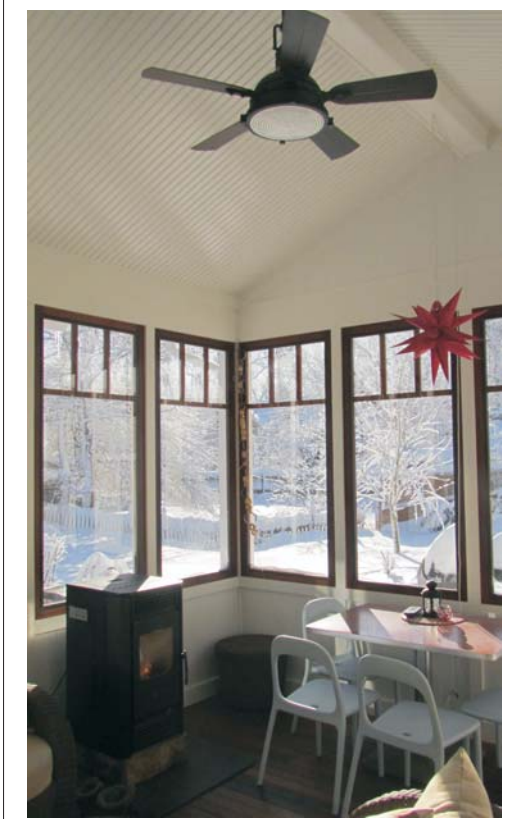

Touchstone Woodworks

Touchstone Woodworks Three Season Divided Lite Knee Wall Panel



This knee wall panel has a Penofin penetrating oil finish

Our knee wall panels are a full 1-1/4" thick mahogany, mortise and tenon joinery, epoxied and pegged through with mahogany pegs.

The screen and storm panels are secured with machine screws and shoulder washers that screw into metal threaded inserts, imbedded in the wood behind the panels.



The removable panel sits in a rabbet, flush with the inside of the knee wall panel. They are easily removed with a flat head screwdriver. The aluminum screen and storm frames are available in white or dark bronze.

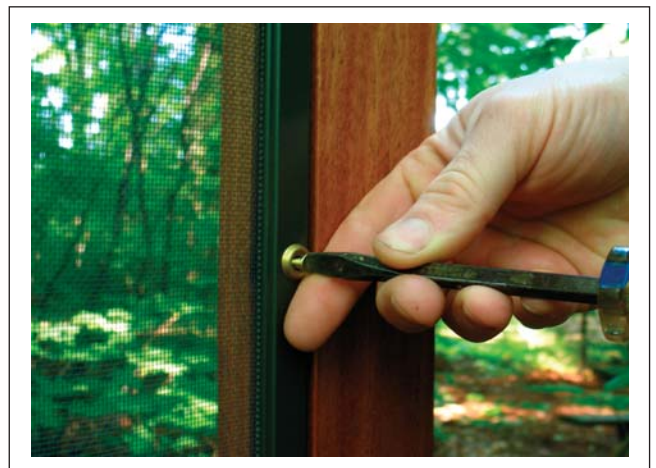

Three Season Porch

BEFORE

Fixed screen porch



AFTER

Three season porch featuring Touchstone Woodworks' Williamsburg wall panels and door.



Three Season Porch

Before: Open deck with pergola

After: Three season porch featuring Touchstone Woodworks' Wellington wall panels and custom double doors.





Three Season Porch

with Touchstone Woodworks' Wall Panels

Before: Open porch

After: Converted to three season porch with
Touchstone Woodworks' Wellington wall panels



THREE SEASON PORCH

The growing popularity of multi-season rooms has led to a wide selection of stylish, quality furnishings for outdoor living spaces including furniture, ceiling fans, lighting, rugs and blinds. With wall panels, transoms and doors from Touchstone Woodworks, you can create an inviting three season porch or room.

Designed like our doors to accept removable and interchangeable screen and tempered glass storm inserts, our solutions allow you to convert an outdoor living space from screen to glass when the weather turns cool and from glass to screen when leaves turn green.

During the warmest season, you can enjoy the open, airy feeling of an old-fashioned screened porch, bringing in the sights and sounds of summer, day and night, without battling the bugs and mosquitos. Exchanging the screen for glass will extend the enjoyment of your room into the spring and fall. The glass will protect the room and furniture from dust, pollen, wind, blowing rain and snow, in addition to serving as an effective sound barrier.

Single Lite Knee Wall Panels

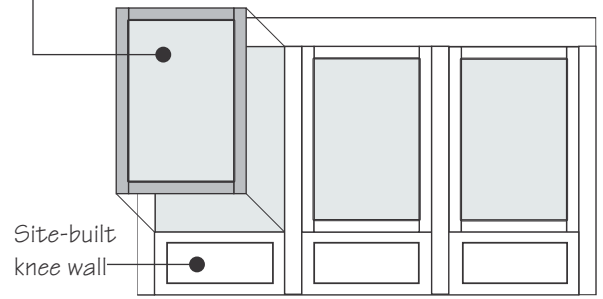

Divided Lite Knee Wall Panels

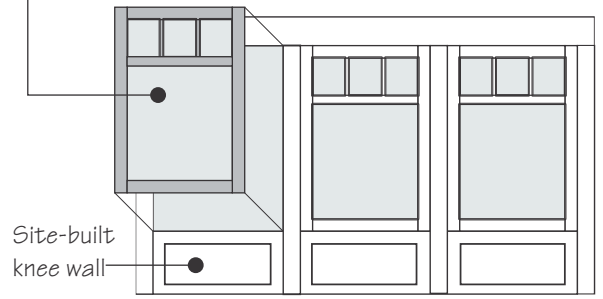

Wellington Wall Panels

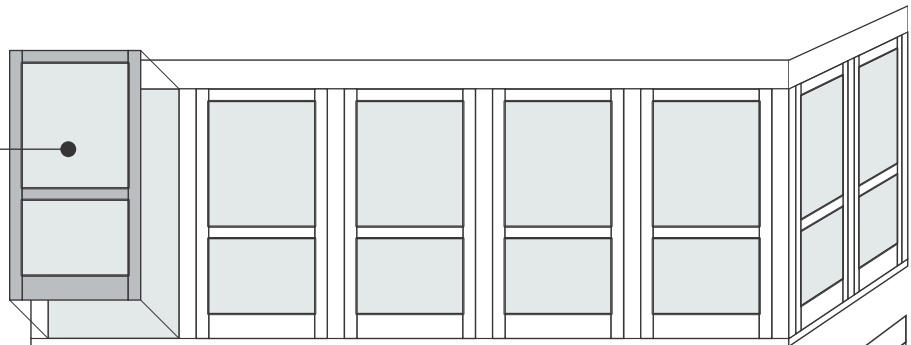

Divided Lite Transoms



Brighton Wall Panels

Craftsman Wall Panels



TOUCHSTONE WOODWORKS THREE SEASON PRODUCT SPECIFICATIONS:

WALL PANELS, TRANSOMS & DOORS: Our wall panels, transoms and doors are a full 1-1/4" thick mahogany, mortise and tenon joinery, epoxied and pegged through with mahogany pegs. On our Wellington wall panels, the middle rails are also mortised and tenoned for added structural integrity. Our products are designed to accept removable and interchangeable screen and tempered glass storm panels. We offer you a choice of white or dark bronze aluminum screen and storm frames. These sit in a rabbet on one side of the unit. The Wellington doors and wall panels have 2 removable screens and storms, divided at the tenoned midrail. The knee wall panels and transoms have one removable screen and storm.

METHOD OF RETAINING & INTERCHANGING SCREEN & GLASS PANELS: Our units are designed to accept removable and interchangeable screens and tempered glass storms. To fasten the screens and glass into the units, we drill holes in the vertical members of the aluminum frames and install corresponding metal threaded inserts in the rabbet of the wood to accept brass or stainless steel machine screws and shoulder washers.

SCREENS: Screen frame is fabricated from .019 gauge roll-formed aluminum, 3/8" thick x 45/64" wide with matching solid plastic corner locks, available in white or dark bronze with black serrated screen spline and charcoal aluminum screen mesh standard.

TEMPERED SAFETY GLASS STORMS: Bi-laminate storm frame is fabricated from .019 gauge aluminum 3/8" thick x 25/32" wide with matching solid plastic corner locks, available in white or dark bronze with 1/8" thick clear tempered safety glass. Tempered glass is four to five times stronger than standard glass and does not break into sharp shards when it fails. If it breaks, it fragments into small harmless rounded pellets. This eliminates the danger of sharp edges. Due to this property, along with its strength, tempered glass is often referred to as safety glass.

FINISHES OFFERED: Oil-based primer, Penofin penetrating oil finish or unfinished. The units should receive a final finish coat on all sides and edges prior to installation.

INSTALLATION: Our units should be allowed to "float" inside a framed opening, as a panel "floats" in a door. This can be done by fastening an inner and outer perimeter of moulding to the framed openings to create a stop on both sides of the floating wall panel. The treatment at the bottom can vary depending on the type of floor, the slope and how the openings are framed. The plan should allow water to shed. One option is a wood "sill plate" around the perimeter of the room to elevate the bottoms of the panels off the floor and provide for a level sill for the panels to sit on. Sill plates can be secured between the posts and scribed to leave a space between the floor and the bottom of the sill plate for water to exit. Another option: shimming under the panels with blocks of composite material (like Trex) and fastening a baseboard trim to the bottom of the panels. On the exterior, create a drainage plane by adding 1/4" thick erosion matting (like Enkamat #7010) between the baseboard and the panel.



CONSTRUCTION DETAILS

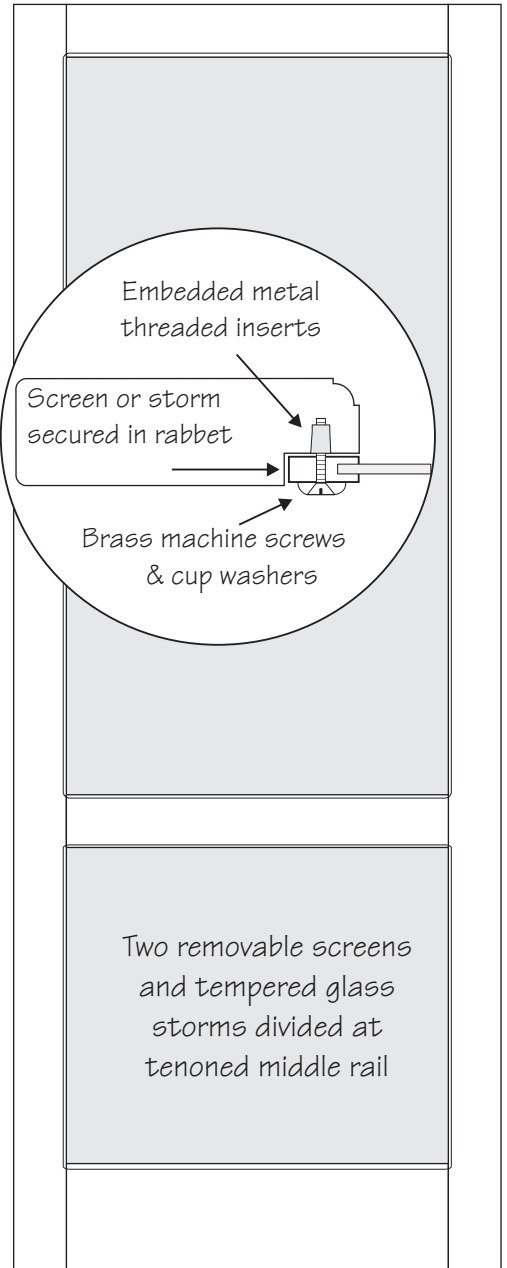

Wellington Style Wall Panel

OUR PRODUCTS ARE INTENDED TO CREATE AN OUTDOOR, THREE SEASON ROOM: an upgrade/alternative to an open air porch or deck or fixed screen porch. They are NOT intended to create a year-round room in a cold climate nor an insulated, water-proof room when the glass is installed. Water seepage can occur at bottom of glass in driving rain. Furnishings, floors and electricity for a three season room created with our wall panels should be rated and designed for outdoor use. The deck or flooring may get wet and should be designed to shed water.

Installation of Touchstone Woodworks 3 Season Wall Panels

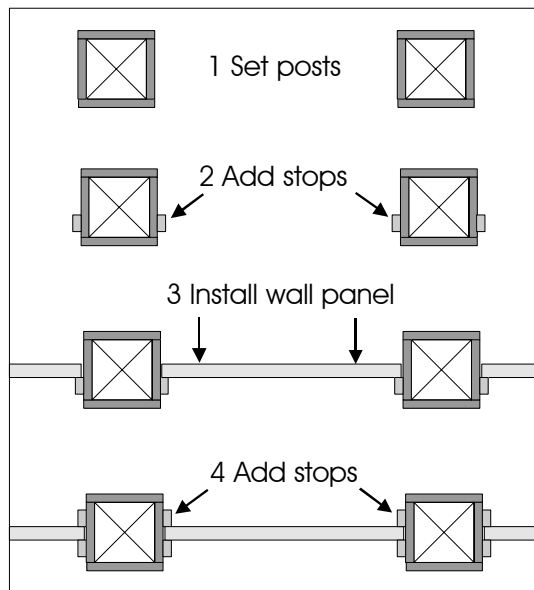
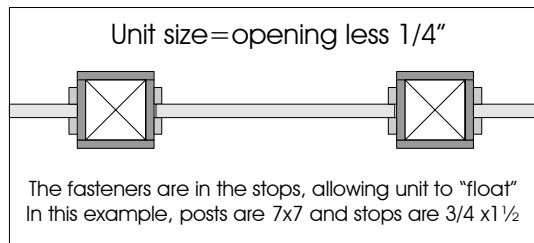

The width of the units depends on the size of the posts.

Typical Post Sizes

Nominal / Actual

Posts placed 43 1/2" on center

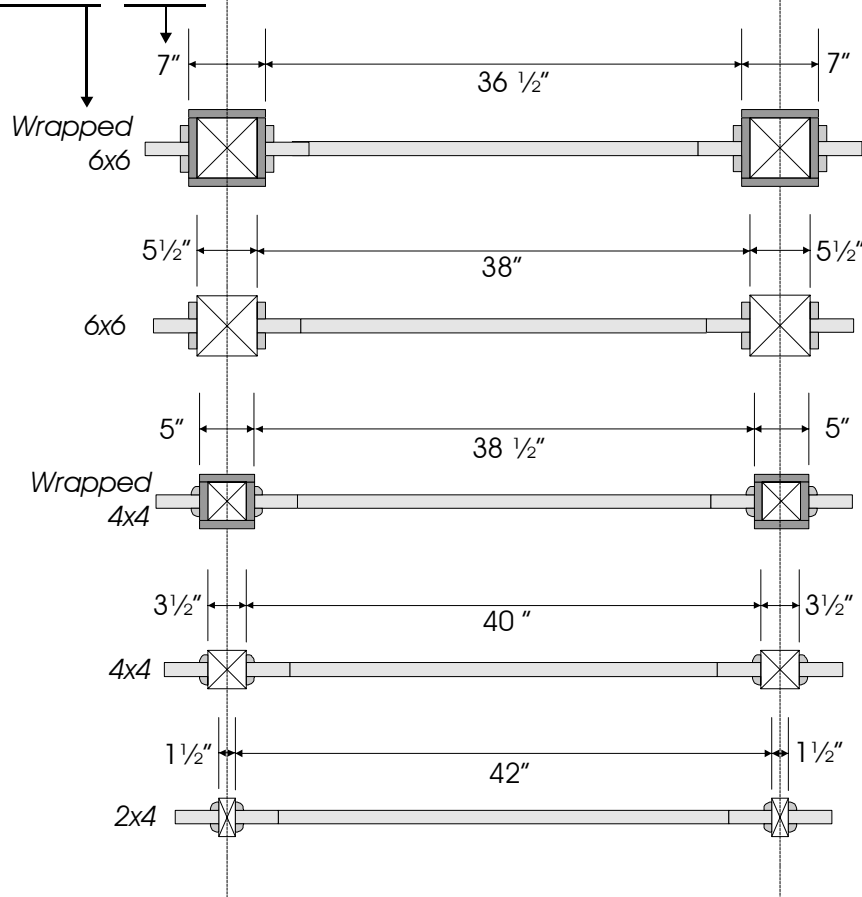

The post and trim sizes shown here are for the purpose of illustrating examples. It is up to the designer/builder to specify construction details, post sizes and spans.

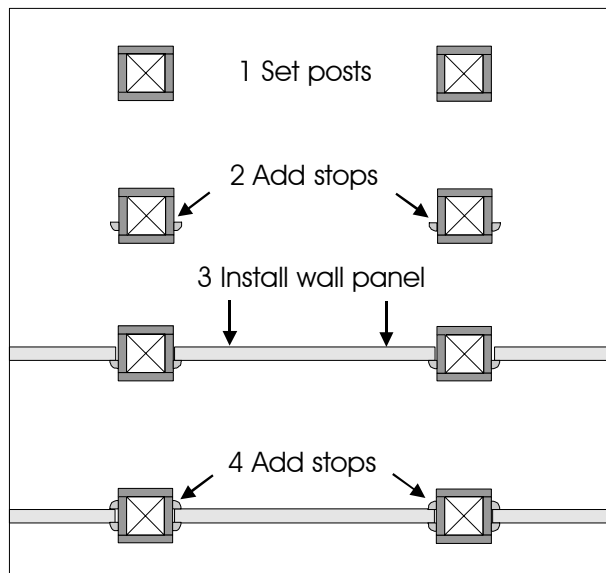
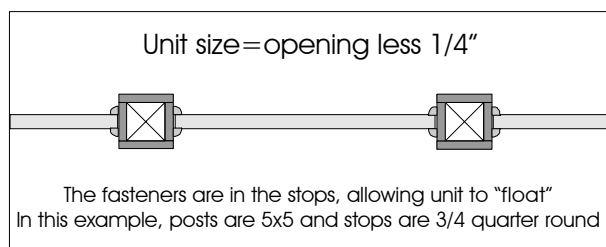

Our units should be allowed to "float" inside a framed opening, as a panel "floats" in a door. This way no stress is put on the joints and the wood can expand and contract. This can be done by fastening an inner and outer perimeter of trim or moulding to the framed openings to create a stop on both sides of the floating wall panel.

All the posts can be the same size or there could be smaller, intermediate framing members located inside larger spans, supported by larger, load-bearing structural posts. Typically the posts support a beam, which supports the roof. These design and structural details should be worked out by the homeowner and the designer/builder prior to ordering the units since the sizes of the units will depend on the sizes of the posts and framing members.

The treatment at the bottom can vary depending on the type of floor, the slope and how the openings are framed. The plan should allow water to shed. One option is a wood "sill plate" around the perimeter of the room to elevate the bottoms of the panels off the floor and provide for a level sill for the panels to sit on. Sill plates can be secured between the posts and scribed to leave a space between the floor and the bottom of the sill plate for water to exit. Another option: shimming under the panels with blocks of composite material (like Trex) and fastening a baseboard trim to the bottom of the panels. On the exterior, create a drainage plane by adding 1/4" thick erosion matting (like Enkamat #7010) between the baseboard and the panel.

Touchstone Woodworks

Wall Panel Installation Option with Wrapped posts

If the posts are wrapped, the post wrap/trim can serve as the stops for retaining the wall panels. In this case, the size of the wall panels would be based on the opening width between the posts rather than based on opening width between the finished dimension of the wrapped posts. Panel width should be sized 1/4" less than opening width between posts.

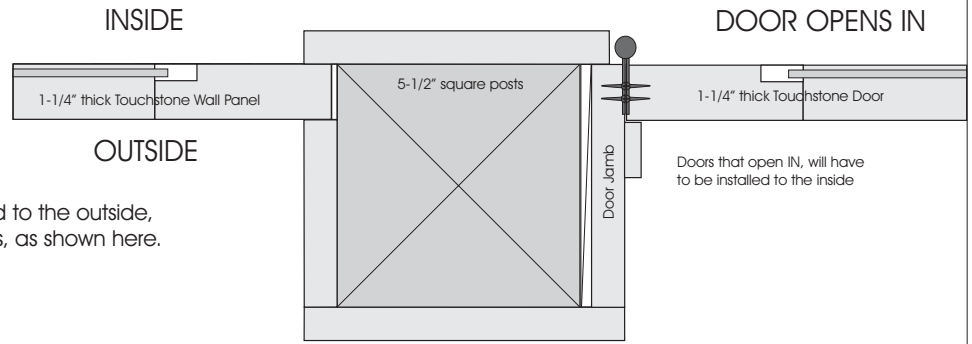
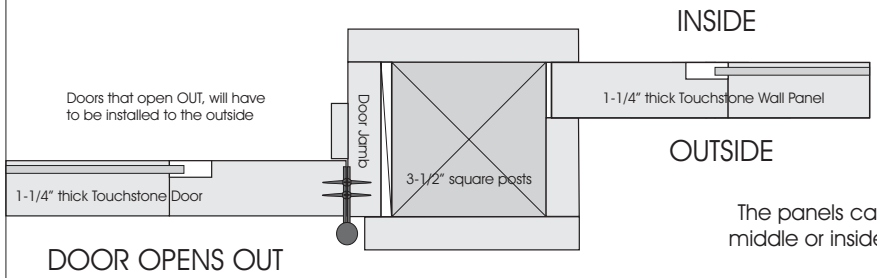

The panels can be installed to the outside, middle or inside of the posts, as shown here.

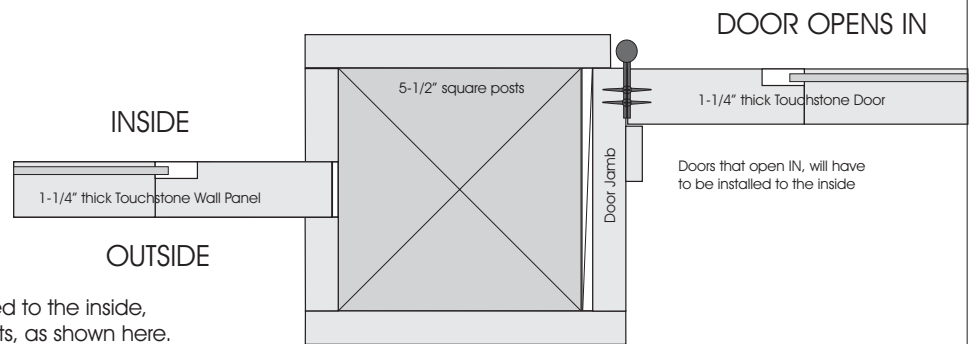
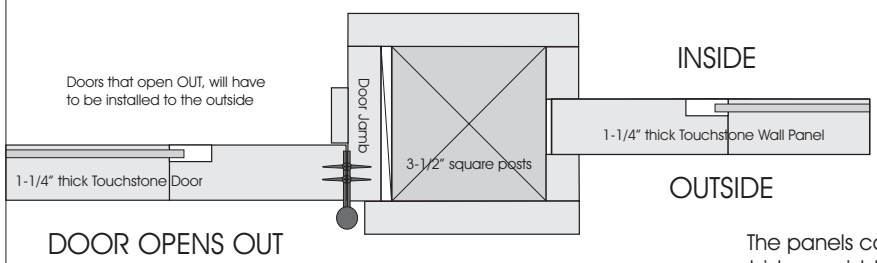

The panels can be installed to the inside, outside or middle of the posts, as shown here.

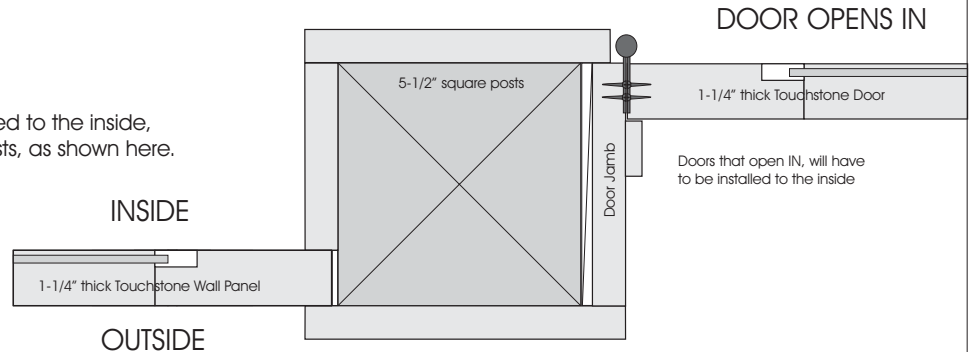
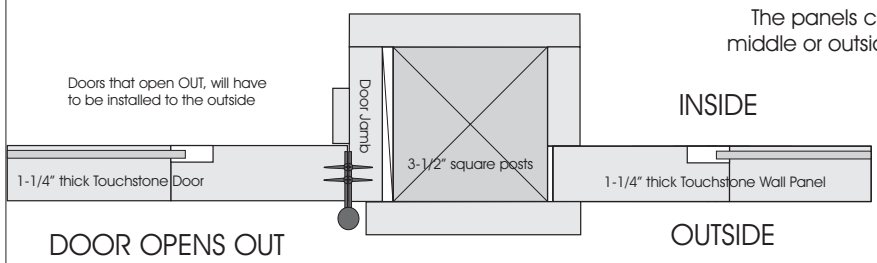

The panels can be installed to the inside, middle or outside of the posts, as shown here.

THIS WOULD BE A TYPICAL SCREENED PORCH INSTALLATION FOR A LEFT HAND IN-SWINGING DOOR SUPPLIED PREHUNG IN A JAMB.

THE DEPTH OF THE JAMB IS TYPICALLY MATCHED TO THE SIZE OF THE POST AND TRIMMED OUT ON BOTH SIDES.

WARNING: IF THE FLOOR SLOPES, THE DOOR NEEDS TO OPEN TOWARD THE LOW END OF THE FLOOR.

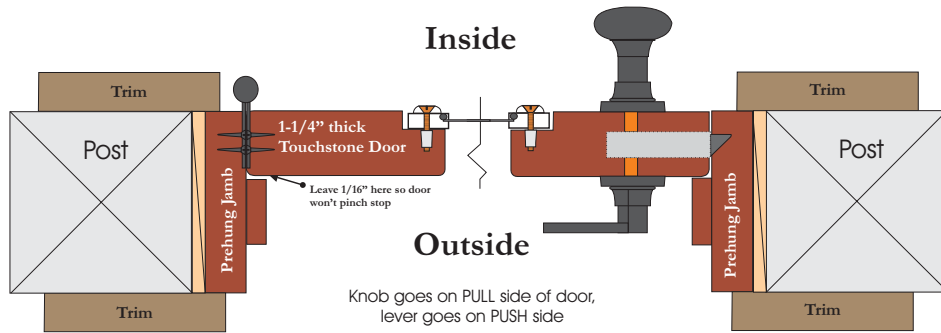

THIS WOULD BE A TYPICAL SCREENED PORCH INSTALLATION FOR A RIGHT HAND OUT-SWINGING DOOR SUPPLIED PREHUNG IN A JAMB.

THE DEPTH OF THE JAMB IS TYPICALLY MATCHED TO THE SIZE OF THE POST AND TRIMMED OUT ON BOTH SIDES. .

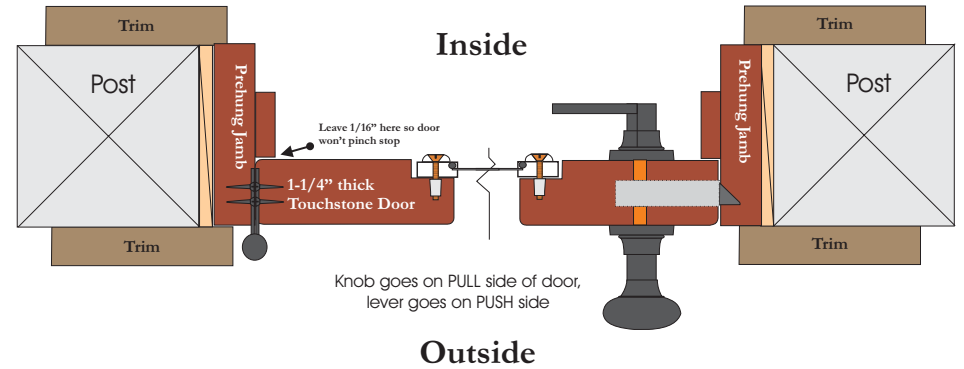

THIS WOULD BE A TYPICAL SCREENED PORCH INSTALLATION FOR A RIGHT HAND IN-SWINGING DOOR SUPPLIED PREHUNG IN A JAMB.

THE DEPTH OF THE JAMB IS TYPICALLY MATCHED TO THE SIZE OF THE POST AND TRIMMED OUT ON BOTH SIDES.

WARNING: IF THE FLOOR SLOPES, THE DOOR NEEDS TO OPEN TOWARD THE LOW END OF THE FLOOR.

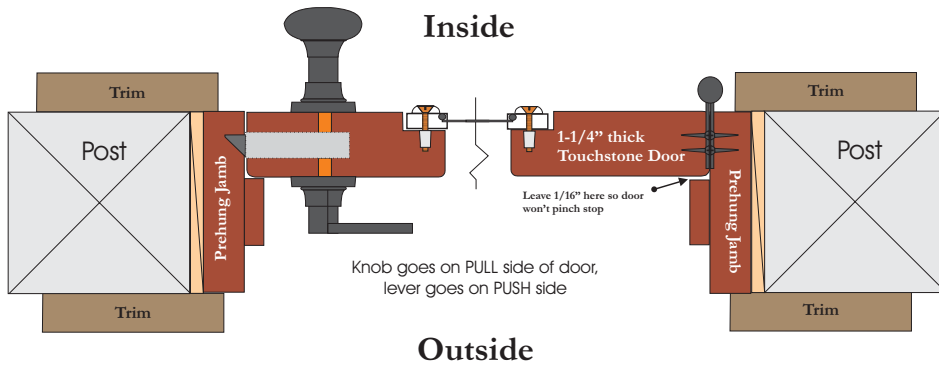

THIS WOULD BE A TYPICAL SCREENED PORCH INSTALLATION FOR A LEFT HAND OUT-SWINGING DOOR SUPPLIED PREHUNG IN A JAMB.

THE DEPTH OF THE JAMB IS TYPICALLY MATCHED TO THE SIZE OF THE POST AND TRIMMED OUT ON BOTH SIDES. .

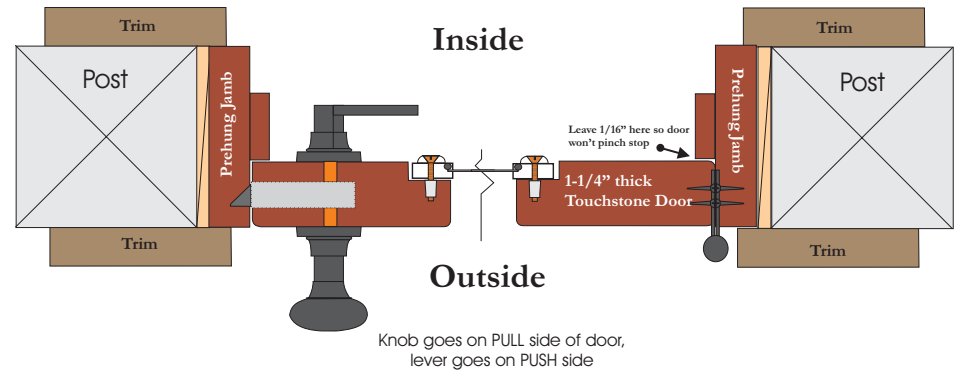

Craftsman 3 Season Wall Panel & Knee Wall Panel

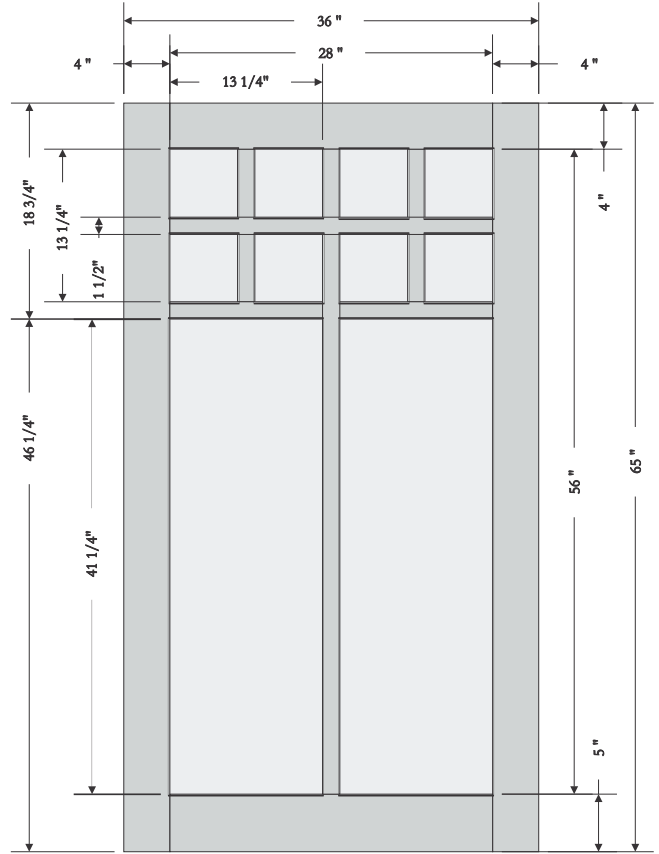
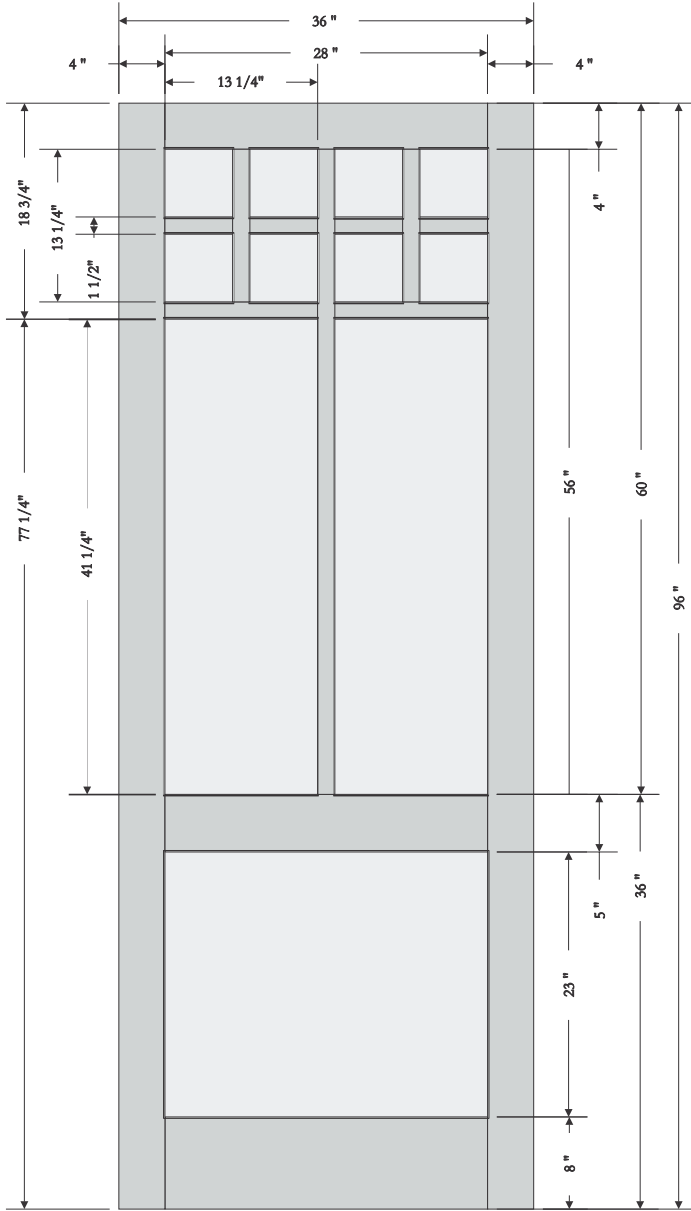

Wellington 3 Season Wall Panels & Transoms

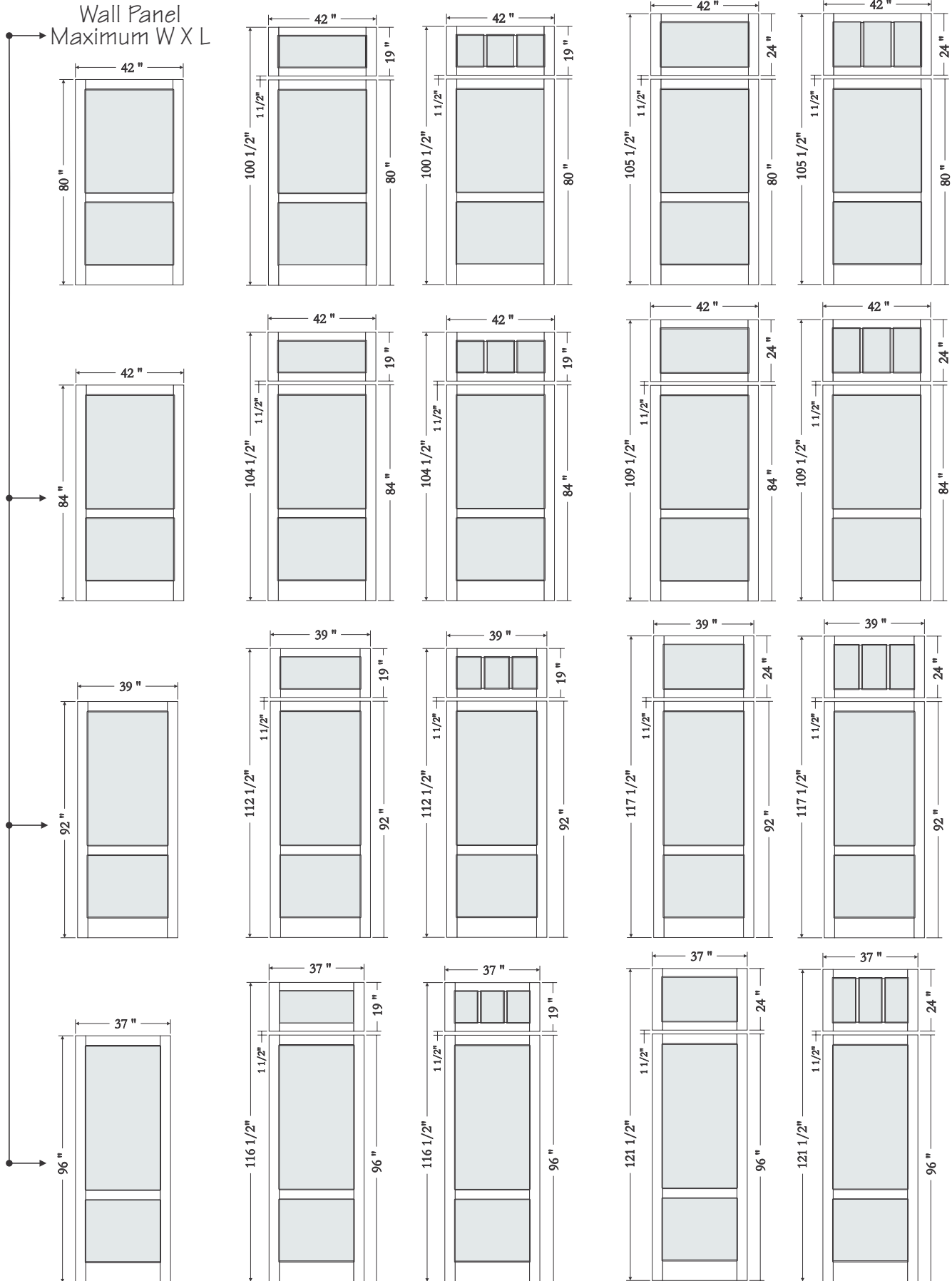

Brighton 3 Season Wall Panels & Transoms

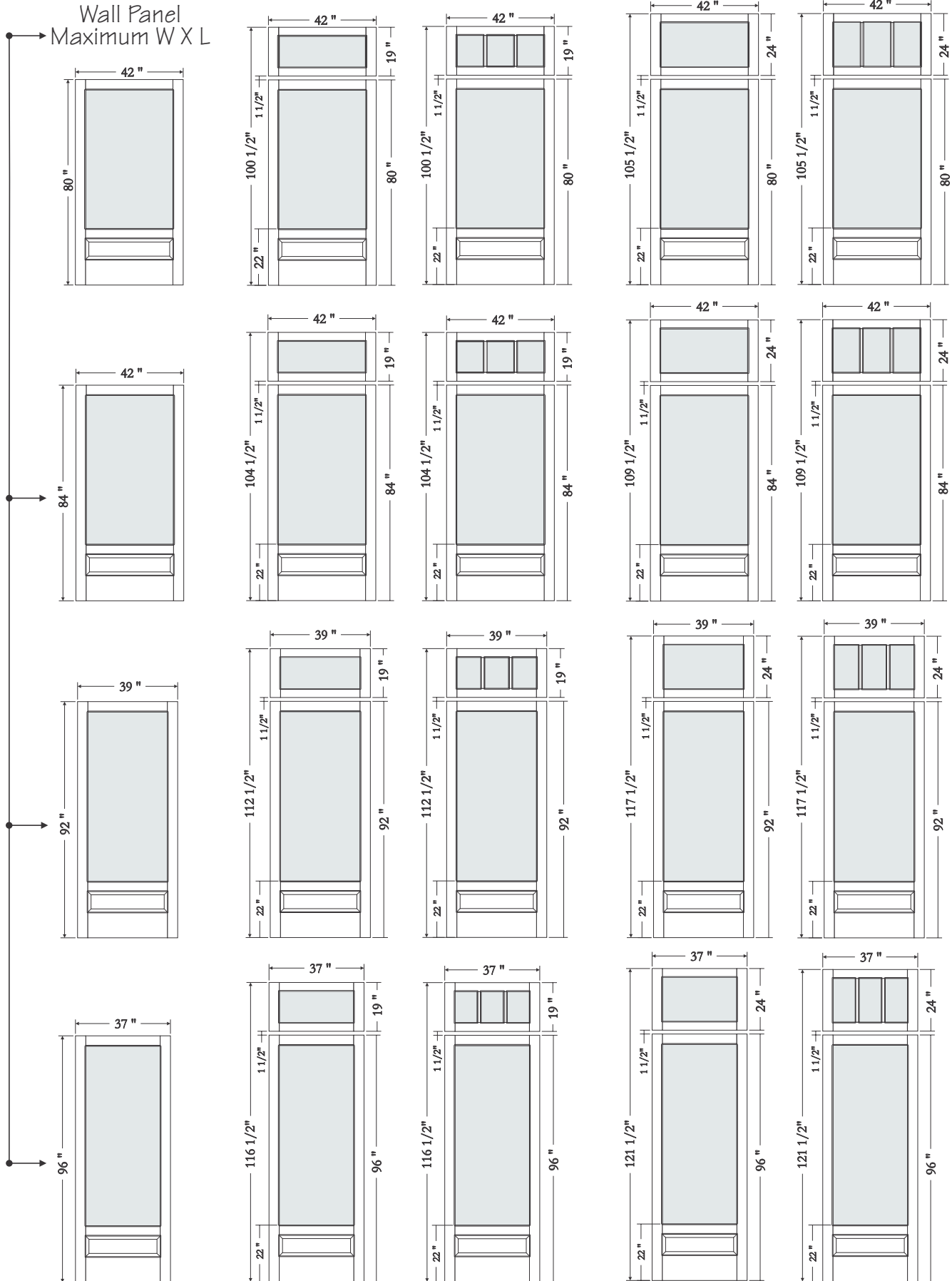

Single Lite & Divided Lite Knee Wall Panels

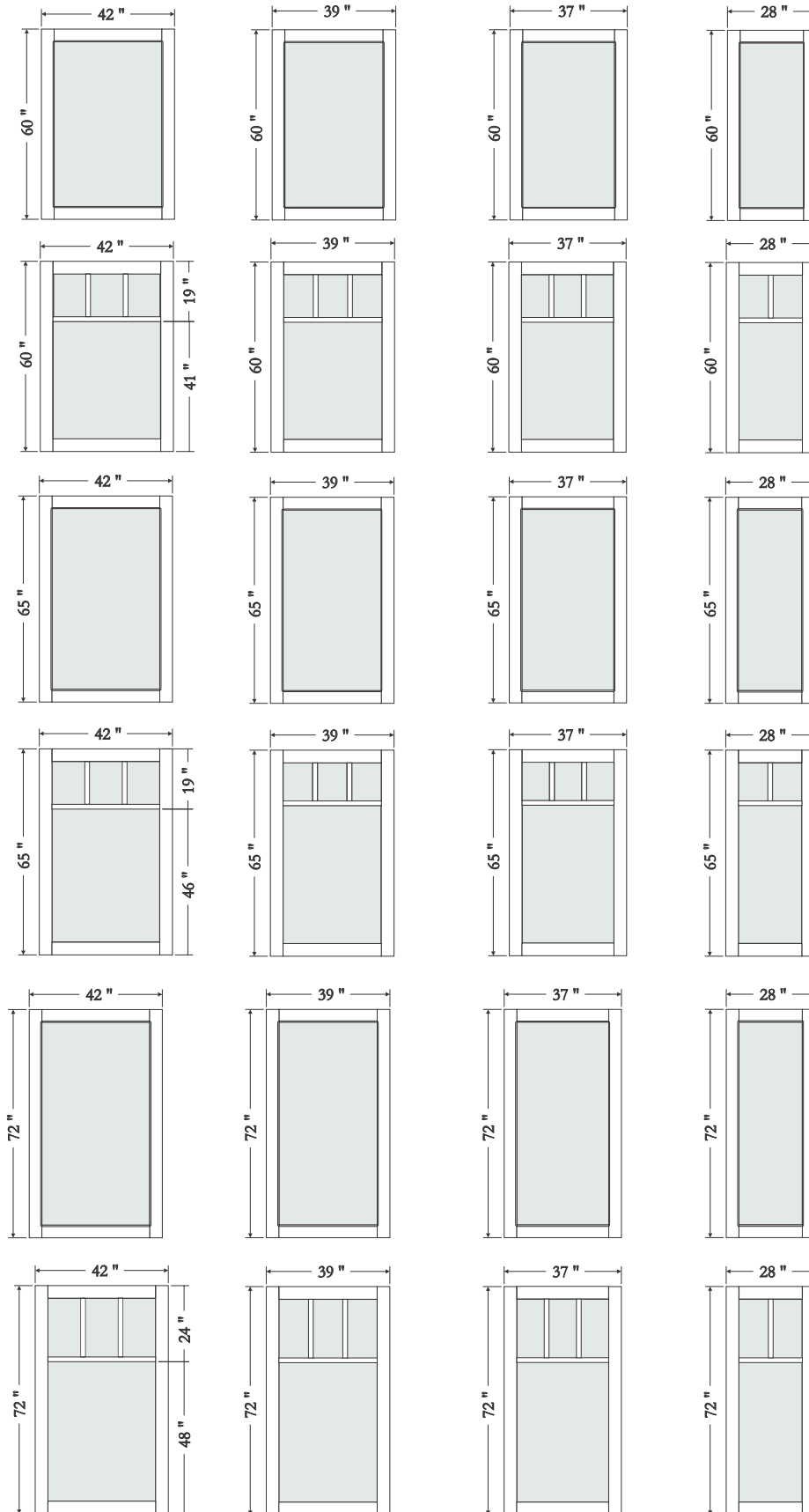

Touchstone Woodworks

THREE SEASON PORCH QUICK PROJECT CALCULATOR

Prices effective February 27, 2013

WELLINGTON WALL PANELS					Total Qty 1	QTY PER WALL			QTY PER ROOM			
Max WXL	Wood	2 Screens	2 Glass	4		5	6	12	14	15	18	
42 X 80	\$869	\$108	\$165	\$1,142	\$4,568	\$5,710	\$6,852	\$13,704	\$15,988	\$17,130	\$20,556	
42 X 84	\$869	\$108	\$165	\$1,142	\$4,568	\$5,710	\$6,852	\$13,704	\$15,988	\$17,130	\$20,556	
39 X 92	\$869	\$108	\$165	\$1,142	\$4,568	\$5,710	\$6,852	\$13,704	\$15,988	\$17,130	\$20,556	
37 X 96	\$869	\$108	\$165	\$1,142	\$4,568	\$5,710	\$6,852	\$13,704	\$15,988	\$17,130	\$20,556	

HATTERAS WALL PANELS					Total Qty 1	QTY PER WALL			QTY PER ROOM			
Max WXL	Wood	2 Screens	2 Glass	4		5	6	12	14	15	18	
42 X 80	\$1,011	\$108	\$165	\$1,284	\$5,136	\$6,420	\$7,704	\$15,408	\$17,976	\$19,260	\$23,112	
42 X 84	\$1,011	\$108	\$165	\$1,284	\$5,136	\$6,420	\$7,704	\$15,408	\$17,976	\$19,260	\$23,112	
39 X 92	\$985	\$108	\$165	\$1,258	\$5,032	\$6,290	\$7,548	\$15,096	\$17,612	\$18,870	\$22,644	
37 X 96	\$985	\$108	\$165	\$1,258	\$5,032	\$6,290	\$7,548	\$15,096	\$17,612	\$18,870	\$22,644	

BRIGHTON WALL PANELS					Total Qty 1	QTY PER WALL			QTY PER ROOM			
Max WXL	Wood	1 Screen	1 Glass	4		5	6	12	14	15	18	
42 X 80	\$984	\$72	\$125	\$1,181	\$4,724	\$5,905	\$7,086	\$14,172	\$16,534	\$17,715	\$21,258	
42 X 84	\$984	\$72	\$125	\$1,181	\$4,724	\$5,905	\$7,086	\$14,172	\$16,534	\$17,715	\$21,258	
39 X 92	\$984	\$72	\$125	\$1,181	\$4,724	\$5,905	\$7,086	\$14,172	\$16,534	\$17,715	\$21,258	
37 X 96	\$984	\$72	\$125	\$1,181	\$4,724	\$5,905	\$7,086	\$14,172	\$16,534	\$17,715	\$21,258	

CRAFTSMAN WALL PANELS					Total Qty 1	QTY PER WALL			QTY PER ROOM			
Max WXL	Wood	2 Screens	2 Glass	4		5	6	12	14	15	18	
36 X 96	\$1,040	\$108	\$165	\$1,313	\$5,252	\$6,565	\$7,878	\$15,756	\$18,382	\$19,695	\$23,634	

TRANSOMS - SINGLE LITE					Total Qty 1	QTY PER WALL			QTY PER ROOM			
Size	Wood	1 Screen	1 Glass	4		5	6	12	14	15	18	
42 X 19	\$339	\$39	\$59	\$437	\$1,748	\$2,185	\$2,622	\$5,244	\$6,118	\$6,555	\$7,866	
42 X 24	\$343	\$39	\$66	\$448	\$1,792	\$2,240	\$2,688	\$5,376	\$6,272	\$6,720	\$8,064	
39 X 19	\$337	\$39	\$57	\$433	\$1,732	\$2,165	\$2,598	\$5,196	\$6,062	\$6,495	\$7,794	
39 X 24	\$341	\$39	\$63	\$443	\$1,772	\$2,215	\$2,658	\$5,316	\$6,202	\$6,645	\$7,974	
37 X 19	\$336	\$39	\$56	\$431	\$1,724	\$2,155	\$2,586	\$5,172	\$6,034	\$6,465	\$7,758	
37 X 24	\$339	\$39	\$62	\$440	\$1,760	\$2,200	\$2,640	\$5,280	\$6,160	\$6,600	\$7,920	

TRANSOMS - DIVIDED LITE					Total Qty 1	QTY PER WALL			QTY PER ROOM			
Size	Wood	1 Screen	1 Glass	4		5	6	12	14	15	18	
42 X 19	\$383	\$39	\$59	\$481	\$1,925	\$2,406	\$2,888	\$5,775	\$6,738	\$7,219	\$8,663	
42 X 24	\$387	\$39	\$66	\$492	\$1,968	\$2,460	\$2,952	\$5,903	\$6,887	\$7,379	\$8,855	
39 X 19	\$381	\$39	\$57	\$477	\$1,909	\$2,386	\$2,864	\$5,727	\$6,682	\$7,159	\$8,591	
39 X 24	\$385	\$39	\$63	\$487	\$1,948	\$2,435	\$2,922	\$5,843	\$6,817	\$7,304	\$8,765	
37 X 19	\$380	\$39	\$56	\$475	\$1,901	\$2,376	\$2,852	\$5,703	\$6,654	\$7,129	\$8,555	
37 X 24	\$383	\$39	\$62	\$484	\$1,936	\$2,420	\$2,904	\$5,807	\$6,775	\$7,259	\$8,711	

KNEE WALL PANELS - SINGLE LITE					Total Qty 1	QTY PER WALL			QTY PER ROOM			
Size	Wood	1 Screen	1 Glass	4		5	6	12	14	15	18	
42 X 72	\$584	\$72	\$147	\$803	\$3,212	\$4,015	\$4,818	\$9,636	\$11,242	\$12,045	\$14,454	
42 X 65	\$576	\$72	\$137	\$785	\$3,140	\$3,925	\$4,710	\$9,420	\$10,990	\$11,775	\$14,130	
42 X 60	\$571	\$72	\$132	\$775	\$3,100	\$3,875	\$4,650	\$9,300	\$10,850	\$11,625	\$13,950	
39 X 72	\$580	\$72	\$139	\$791	\$3,164	\$3,955	\$4,746	\$9,492	\$11,074	\$11,865	\$14,238	
39 X 65	\$573	\$72	\$130	\$775	\$3,100	\$3,875	\$4,650	\$9,300	\$10,850	\$11,625	\$13,950	
39 X 60	\$567	\$72	\$125	\$764	\$3,056	\$3,820	\$4,584	\$9,168	\$10,696	\$11,460	\$13,752	
37 X 72	\$578	\$72	\$135	\$785	\$3,140	\$3,925	\$4,710	\$9,420	\$10,990	\$11,775	\$14,130	
37 X 65	\$571	\$72	\$126	\$769	\$3,076	\$3,845	\$4,614	\$9,228	\$10,766	\$11,535	\$13,842	
37 X 60	\$565	\$72	\$121	\$758	\$3,032	\$3,790	\$4,548	\$9,096	\$10,612	\$11,370	\$13,644	
28 X 72	\$569	\$72	\$117	\$758	\$3,032	\$3,790	\$4,548	\$9,096	\$10,612	\$11,370	\$13,644	
28 X 65	\$561	\$72	\$110	\$743	\$2,972	\$3,715	\$4,458	\$8,916	\$10,402	\$11,145	\$13,374	
28 X 60	\$556	\$72	\$107	\$735	\$2,940	\$3,675	\$4,410	\$8,820	\$10,290	\$11,025	\$13,230	

KNEE WALL PANELS - DIVIDED LITE					Total Qty 1	QTY PER WALL			QTY PER ROOM			
Size	Wood	1 Screen	1 Glass	4		5	6	12	14	15	18	
42 X 72	\$660	\$72	\$147	\$879	\$3,516	\$4,395	\$5,274	\$10,548	\$12,306	\$13,185	\$15,822	
42 X 65	\$651	\$72	\$137	\$860	\$3,441	\$4,301	\$5,161	\$10,322	\$12,043	\$12,903	\$15,484	
42 X 60	\$646	\$72	\$132	\$850	\$3,401	\$4,251	\$5,101	\$10,202	\$11,903	\$12,753	\$15,304	
39 X 72	\$656	\$72	\$139	\$867	\$3,468	\$4,335	\$5,202	\$10,404	\$12,138	\$13,005	\$15,606	
39 X 65	\$648	\$72	\$130	\$850	\$3,401	\$4,251	\$5,101	\$10,202	\$11,903	\$12,753	\$15,304	
39 X 60	\$642	\$72	\$125	\$839	\$3,357	\$4,196	\$5,035	\$10,070	\$11,749	\$12,588	\$15,106	
37 X 72	\$654	\$72	\$135	\$861	\$3,444	\$4,305	\$5,166	\$10,332	\$12,054	\$12,915	\$15,498	
37 X 65	\$646	\$72	\$126	\$844	\$3,377	\$4,221	\$5,065	\$10,130	\$11,819	\$12,663	\$15,196	
37 X 60	\$640	\$72	\$121	\$833	\$3,333	\$4,166	\$4,999	\$9,998	\$11,665	\$12,498	\$14,998	
28 X 72	\$618	\$72	\$117	\$807	\$3,228	\$4,035	\$4,842	\$9,685	\$11,299	\$12,106	\$14,527	
28 X 65	\$610	\$72	\$110	\$792	\$3,170	\$3,962	\$4,755	\$9,509	\$11,094	\$11,886	\$14,264	
28 X 60	\$605	\$72	\$107	\$784	\$3,138	\$3,922	\$4,707	\$9,413	\$10,982	\$11,766	\$14,120	

CRAFTSMAN KNEE WALL PANELS					Total Qty 1	QTY PER WALL			QTY PER ROOM			
Size	Wood	1 Screen	1 Glass	4		5	6	12	14	15	18	
36 X 65	\$742	\$72	\$126	\$940	\$3,760	\$4,700	\$5,640	\$11,280	\$13,160	\$14,100	\$16,920	

Note: This pricing is for the purposes of rough estimating. It does not include freight or hardware for functional doors

Touchstone Woodworks

THREE SEASON PORCH QUICK PROJECT CALCULATOR

Prices effective February 27, 2013

WELLINGTON WALL PANELS WITH INTEGRATED TRANSOMS											
Max WXL	Wood	3		Total Qty 1	QTY PER WALL			QTY PER ROOM			
		Screens	Glass		4	5	6	12	14	15	18
42 X 80	\$969	\$147	\$225	\$1,341	\$5,364	\$6,705	\$8,046	\$16,092	\$18,774	\$20,115	\$24,138
42 X 84	\$969	\$147	\$225	\$1,341	\$5,364	\$6,705	\$8,046	\$16,092	\$18,774	\$20,115	\$24,138
39 X 92	\$969	\$147	\$225	\$1,341	\$5,364	\$6,705	\$8,046	\$16,092	\$18,774	\$20,115	\$24,138
37 X 96	\$969	\$147	\$225	\$1,341	\$5,364	\$6,705	\$8,046	\$16,092	\$18,774	\$20,115	\$24,138

HATTERAS WALL PANELS WITH INTEGRATED TRANSOMS											
Max WXL	Wood	3		Total Qty 1	QTY PER WALL			QTY PER ROOM			
		Screens	Glass		4	5	6	12	14	15	18
42 X 80	\$1,111	\$147	\$225	\$1,483	\$5,932	\$7,415	\$8,898	\$17,796	\$20,762	\$22,245	\$26,694
42 X 84	\$1,111	\$147	\$225	\$1,483	\$5,932	\$7,415	\$8,898	\$17,796	\$20,762	\$22,245	\$26,694
39 X 92	\$1,085	\$147	\$225	\$1,457	\$5,828	\$7,285	\$8,742	\$17,484	\$20,398	\$21,855	\$26,226
37 X 96	\$1,085	\$147	\$225	\$1,457	\$5,828	\$7,285	\$8,742	\$17,484	\$20,398	\$21,855	\$26,226

BRIGHTON WALL PANELS WITH INTEGRATED TRANSOMS											
Max WXL	Wood	2		Total Qty 1	QTY PER WALL			QTY PER ROOM			
		Screens	Glass		4	5	6	12	14	15	18
42 X 80	\$1,084	\$108	\$165	\$1,357	\$5,428	\$6,785	\$8,142	\$16,284	\$18,998	\$20,355	\$24,426
42 X 84	\$1,084	\$108	\$165	\$1,357	\$5,428	\$6,785	\$8,142	\$16,284	\$18,998	\$20,355	\$24,426
39 X 92	\$1,084	\$108	\$165	\$1,357	\$5,428	\$6,785	\$8,142	\$16,284	\$18,998	\$20,355	\$24,426
37 X 96	\$1,084	\$108	\$165	\$1,357	\$5,428	\$6,785	\$8,142	\$16,284	\$18,998	\$20,355	\$24,426

CRAFTSMAN WALL PANELS WITH INTEGRATED TRANSOMS											
Max WXL	Wood	3		Total Qty 1	QTY PER WALL			QTY PER ROOM			
		Screens	Glass		4	5	6	12	14	15	18
36 X 96	\$1,140	\$147	\$225	\$1,512	\$6,048	\$7,560	\$9,072	\$18,144	\$21,168	\$22,680	\$27,216

KNEE WALL PANELS - SINGLE LITE WITH INTEGRATED TRANSOMS											
Size	Wood	2		Total Qty 1	QTY PER WALL			QTY PER ROOM			
		Screens	Glass		4	5	6	12	14	15	18
42 X 72	\$684	\$108	\$177	\$969	\$3,876	\$4,845	\$5,814	\$11,628	\$13,566	\$14,535	\$17,442
42 X 65	\$676	\$108	\$167	\$951	\$3,804	\$4,755	\$5,706	\$11,412	\$13,314	\$14,265	\$17,118
42 X 60	\$671	\$108	\$162	\$941	\$3,764	\$4,705	\$5,646	\$11,292	\$13,174	\$14,115	\$16,938
39 X 72	\$680	\$108	\$169	\$957	\$3,828	\$4,785	\$5,742	\$11,484	\$13,398	\$14,355	\$17,226
39 X 65	\$673	\$108	\$160	\$941	\$3,764	\$4,705	\$5,646	\$11,292	\$13,174	\$14,115	\$16,938
39 X 60	\$667	\$108	\$155	\$930	\$3,720	\$4,650	\$5,580	\$11,160	\$13,020	\$13,950	\$16,740
37 X 72	\$678	\$108	\$165	\$951	\$3,804	\$4,755	\$5,706	\$11,412	\$13,314	\$14,265	\$17,118
37 X 65	\$671	\$108	\$156	\$935	\$3,740	\$4,675	\$5,610	\$11,220	\$13,090	\$14,025	\$16,830
37 X 60	\$665	\$108	\$151	\$924	\$3,696	\$4,620	\$5,544	\$11,088	\$12,936	\$13,860	\$16,632
28 X 72	\$669	\$108	\$147	\$924	\$3,696	\$4,620	\$5,544	\$11,088	\$12,936	\$13,860	\$16,632
28 X 65	\$661	\$108	\$140	\$909	\$3,636	\$4,545	\$5,454	\$10,908	\$12,726	\$13,635	\$16,362
28 X 60	\$656	\$108	\$137	\$901	\$3,604	\$4,505	\$5,406	\$10,812	\$12,614	\$13,515	\$16,218

KNEE WALL PANELS - DIVIDED LITE WITH INTEGRATED TRANSOMS											
Size	Wood	2		Total Qty 1	QTY PER WALL			QTY PER ROOM			
		Screens	Glass		4	5	6	12	14	15	18
42 X 72	\$760	\$108	\$177	\$1,045	\$4,180	\$5,225	\$6,270	\$12,540	\$14,630	\$15,675	\$18,810
42 X 65	\$751	\$108	\$167	\$1,026	\$4,105	\$5,131	\$6,157	\$12,314	\$14,367	\$15,393	\$18,472
42 X 60	\$746	\$108	\$162	\$1,016	\$4,065	\$5,081	\$6,097	\$12,194	\$14,227	\$15,243	\$18,292
39 X 72	\$756	\$108	\$169	\$1,033	\$4,132	\$5,165	\$6,198	\$12,396	\$14,462	\$15,495	\$18,594
39 X 65	\$748	\$108	\$160	\$1,016	\$4,065	\$5,081	\$6,097	\$12,194	\$14,227	\$15,243	\$18,292
39 X 60	\$742	\$108	\$155	\$1,005	\$4,021	\$5,026	\$6,031	\$12,062	\$14,073	\$15,078	\$18,094
37 X 72	\$754	\$108	\$165	\$1,027	\$4,108	\$5,135	\$6,162	\$12,324	\$14,378	\$15,405	\$18,486
37 X 65	\$746	\$108	\$156	\$1,010	\$4,041	\$5,051	\$6,061	\$12,122	\$14,143	\$15,153	\$18,184
37 X 60	\$740	\$108	\$151	\$999	\$3,997	\$4,996	\$5,995	\$11,990	\$13,989	\$14,988	\$17,986
28 X 72	\$718	\$108	\$147	\$973	\$3,892	\$4,865	\$5,838	\$11,677	\$13,623	\$14,596	\$17,515
28 X 65	\$710	\$108	\$140	\$958	\$3,834	\$4,792	\$5,751	\$11,501	\$13,418	\$14,376	\$17,252
28 X 60	\$705	\$108	\$137	\$950	\$3,802	\$4,752	\$5,703	\$11,405	\$13,306	\$14,256	\$17,108

CRAFTSMAN KNEE WALL PANELS WITH INTEGRATED TRANSOMS											
Size	Wood	2		Total Qty 1	QTY PER WALL			QTY PER ROOM			
		Screens	Glass		4	5	6	12	14	15	18
36 X 65	\$842	\$108	\$156	\$1,106	\$4,424	\$5,530	\$6,636	\$13,272	\$15,484	\$16,590	\$19,908

Note: This pricing is for the purposes of rough estimating. It does not include freight or hardware for functional doors